

# EBP A

Vertical drop-down electric lock, for  
automated swinging gates



**BFT**

Be ahead

# EBP A



- Vertical drop-down electric lock, for automated swinging gates.
- The product is an important accessory for completing the installation in order to safeguard gear motors installed on large gates. It is also an essential element for locking the leaves when gates are equipped with reversible operators.
- Available in 230V, 120V and in the new 24V version, it is directly connected to the control unit.
- The wide operating temperature range of  $-20^{\circ}\text{C}$   $+55^{\circ}\text{C}$  allows it to be used in a large number of applications.
- Depending on the type of BFT control unit, the new EBP A models link together to operate with the ground bolt retracted throughout the movement of the gate or just for the initial part of the movement or in both modes, according to the installer's choice.



# Relevant features

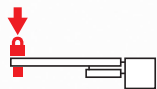

**Higher protection for the installation:** the electric lock makes it possible to create installations that better withstand the forces applied to the leaves in swinging gates, especially large ones, such as pushes from people or forces generated by the action of the wind. These forces are transferred to the electromechanical lock instead of the gear motor, providing a longer life and better operation over time.



**Offer completion for reversible operators:** the electric lock is an essential accessory for installations involving the use of reversible operators, in order to provide locking for the gate when closing.

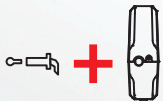

**Addition of the external key release:** for all models of the new EBP A the external key unit can be added at any time, available in two sizes of either 52 or 75 mm. The accessory includes the internal unit, which has the same key as external one, which will be replaced by the one in the electric lock.

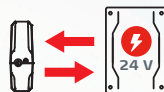

**Range extension:** the new EBP A model in 24V, which is directly connected to the control unit, allows safe low-voltage swing gate installations to be completed easily and quickly.



**Outward opening:** the EBP A electric lock can be installed either on swing gates that open inwards or on gates that open outwards (the plate with the ground hole must be installed in the correct direction).

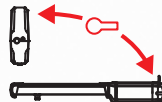



**Simplicity of a single key for the entire system:** it is possible to request the new EBP A with a specific internal key block, or request accessories with internal and external blocks with a specific key number, so that the same key can be used to unlock the operator, operate the selector switch and release the electric lock.



**Design:** the look of the product has been updated - in line with Bft's modern style - allowing it to be perfectly integrated into the installation environment.

# Technical features

Code	Name	Description
P123032 00001	EBP AC A 230V 50/60HZ 	230V vertical electric lock.
P123032 00003	EBP BT A 24V 	24V vertical electric lock.
P123032 00002	EBP AC A 120V 50/60Hz 	120V vertical electric lock.

	EBP AC A 230V 50/60HZ	EBP BT A 24V	EBP AC A 120V 50/60Hz
Power supply	220-230V 50/60 Hz	24V ± 10% 50/60 Hz or DC	120V 50/60 Hz
Inrush current	1,20 A	1,20 A	1,20 A
Holding current for the retracted bolt	200 mA	1000 mA	400 mA
Thermal protection	Yes	Yes	Yes
Operating temperature	-20 ÷ 55 °C	-20 ÷ 55 °C	-20 ÷ 55 °C
IP Rating	IP44	IP44	IP44

## Recommended accessories



 P123033  
**CSE 52 (EXTERNAL RELEASE EBP 52 MM)**

Key cylinder for external release for gates of max. thickness 50 mm. Also includes internal key cylinder with same key number.



 P123034  
**CSE 75 (EXTERNAL RELEASE EBP 75 MM)**

Key cylinder for external release for gates of max. thickness 75 mm. Also includes internal key cylinder with same key number.

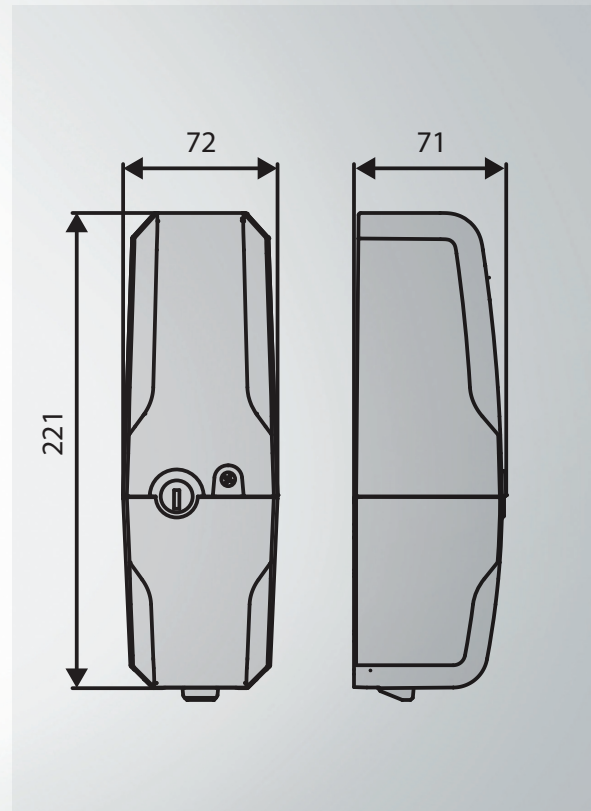

The contents of this catalogue (images, technical descriptions, illustrations) are the exclusive property of Bft s.p.a. Reproduction in any form and on any medium is forbidden. Copyright 2015. All rights reserved. The information given in this publication is only a guide. Bft reserves the right to make any changes without prior notice.



## Bft Spa

Via Lago di Vico, 44 - 36015 Schio (VI) ITALY

T. +39 0445 696511 - F. +39 0445 69 65 22 - info@bft.it

[www.bft-automation.com](http://www.bft-automation.com)

**BFT** | A BRAND OF SOMFY<sup>®</sup> GROUP

rev04 (26-06-2022)



Be ahead